



PURKEYS

WATT Keeps You Trucking

Welcome!

Charging Liftgate Batteries - Part 1
“Why You Need it, What it Does & How it Works”

April 23, 2014 | 12:00 P.M. CDT

Proprietary Information



Bruce Purkey

Founder & Chief Creative Engineer

Bruce has over 40 years' experience servicing fleets' electrical needs. Widely recognized as the authority on electrical issues in the heavy-duty trucking industry, Bruce has worked closely with some of the largest fleets in North America.

800-219-1269
bpurkey@purkeys.net

Several of his inventions have been awarded US patents and earned the Technology & Maintenance Council's Silver Spark Plug award, one of the highest honors awarded to members.



WATT Keeps You Trucking

Charging Liftgates - Not a New Problem

- Why is Charging Liftgate Batteries a Problem?
- Single Pole
- Dual Pole
- Reefer Charging
- DC/DC Converters

Traditional Charging Chart

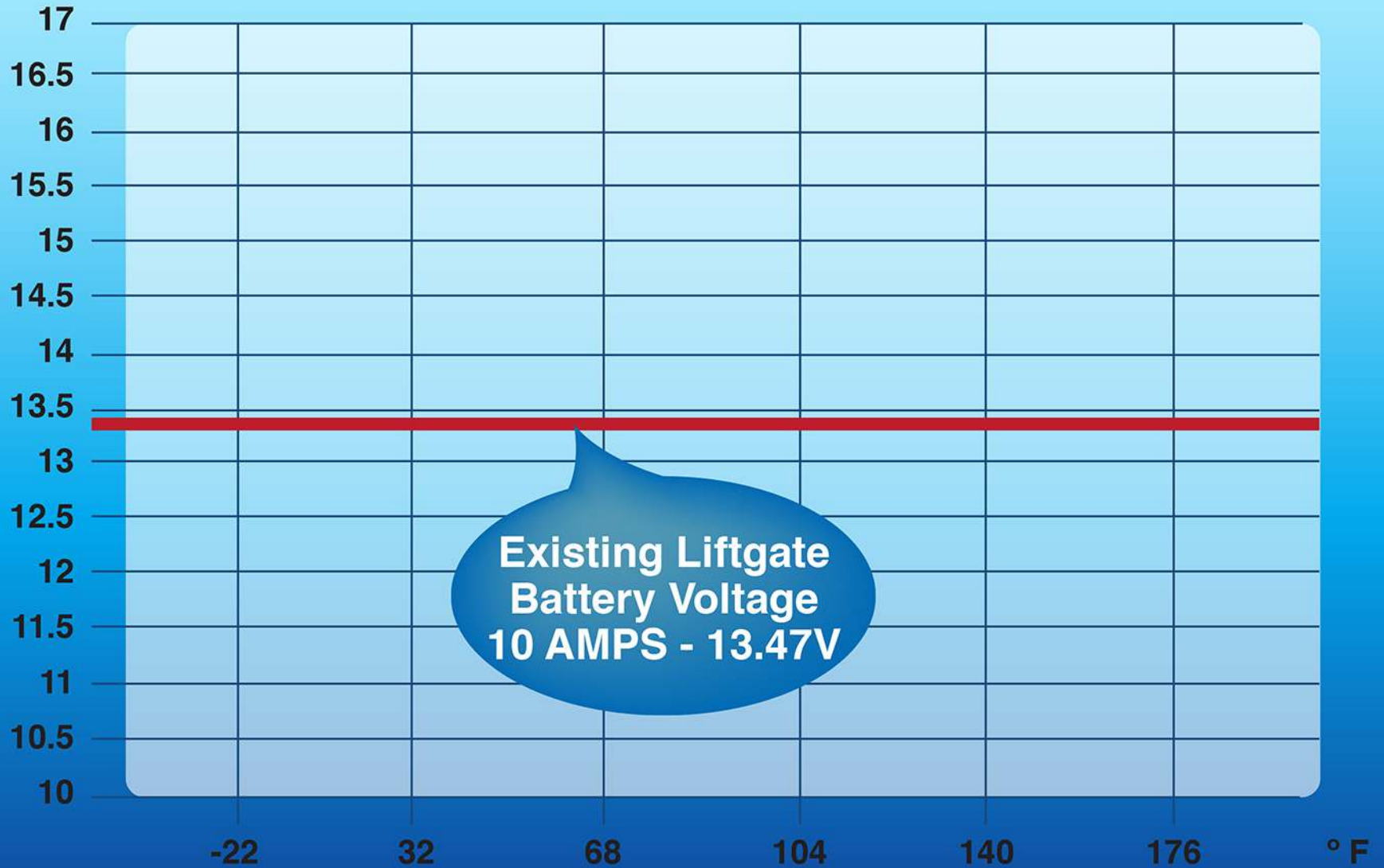

Traditional Charging Chart Continued

Liftgate Charging Webinar – Part 1

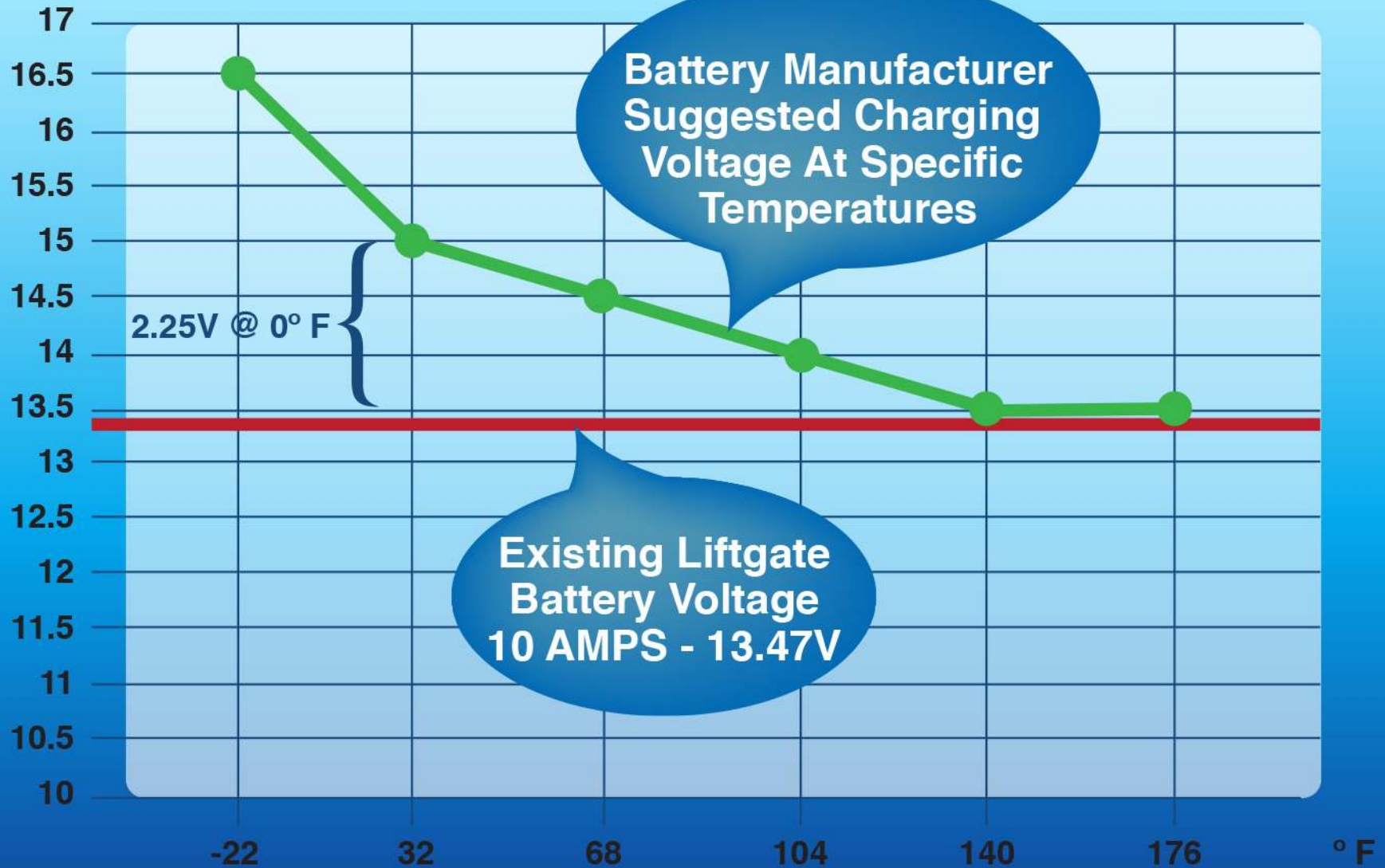

Single Pole Charging Diagram

Liftgate Charging Webinar – Part 1

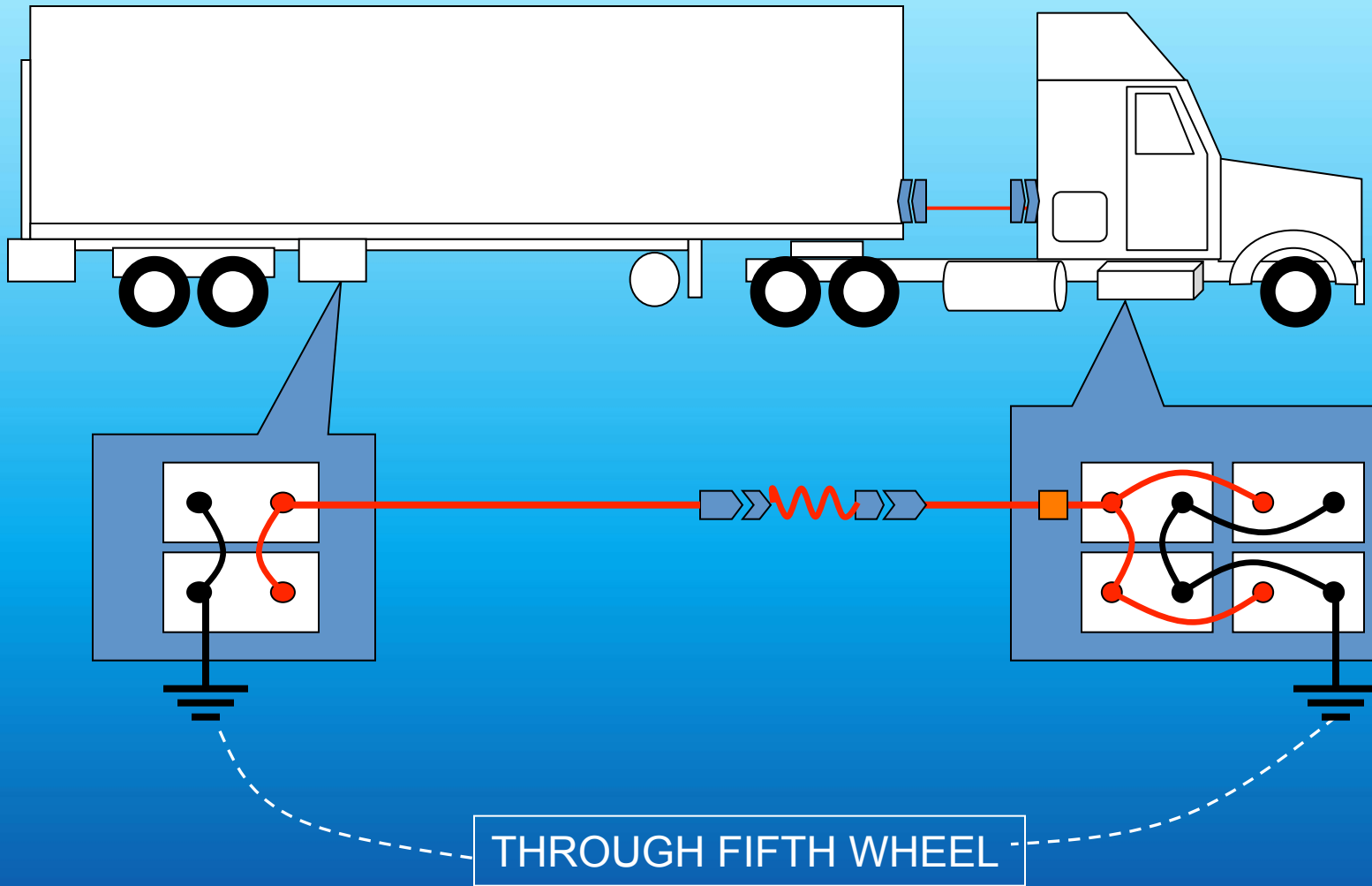

Single Pole Charging Systems

- One single positive cable connection between tractor and trailer batteries
- Connected with an insulated plug
- Ground depends on:
 - How well fifth wheel is bolted to frame
 - Contact between fifth wheel plate and trailer king pin plate
- Fifth wheel grease, turning, corrosion, etc. impacts ground circuit



Dual Pole Charging Diagram

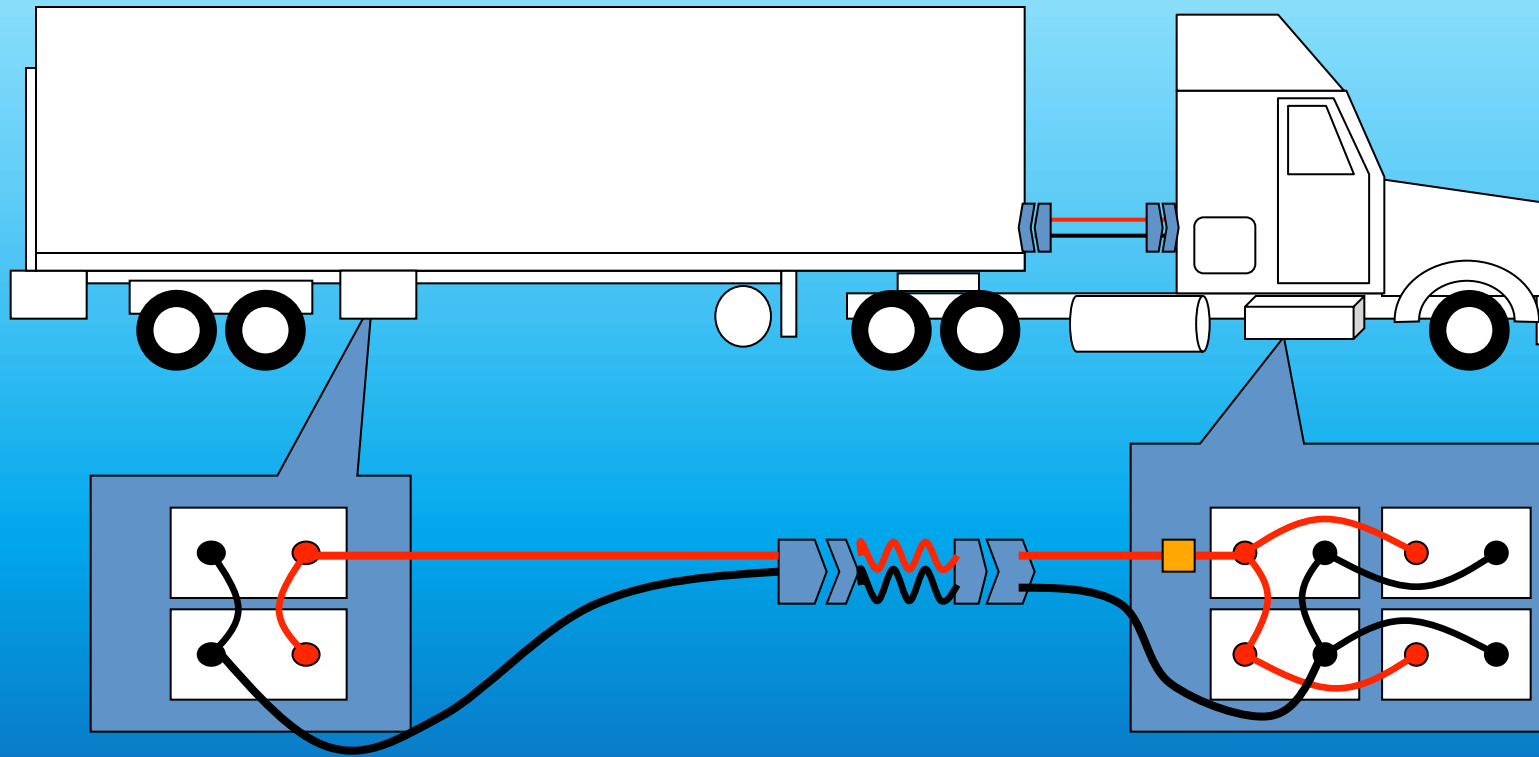

Dual Pole Charging Systems

- Now you have a complete copper circuit on both the positive and negative circuit
- Still have voltage drop in the circuit
- Cannot control where current flows

Reefer Charging Diagram

Liftgate Charging Webinar – Part 1

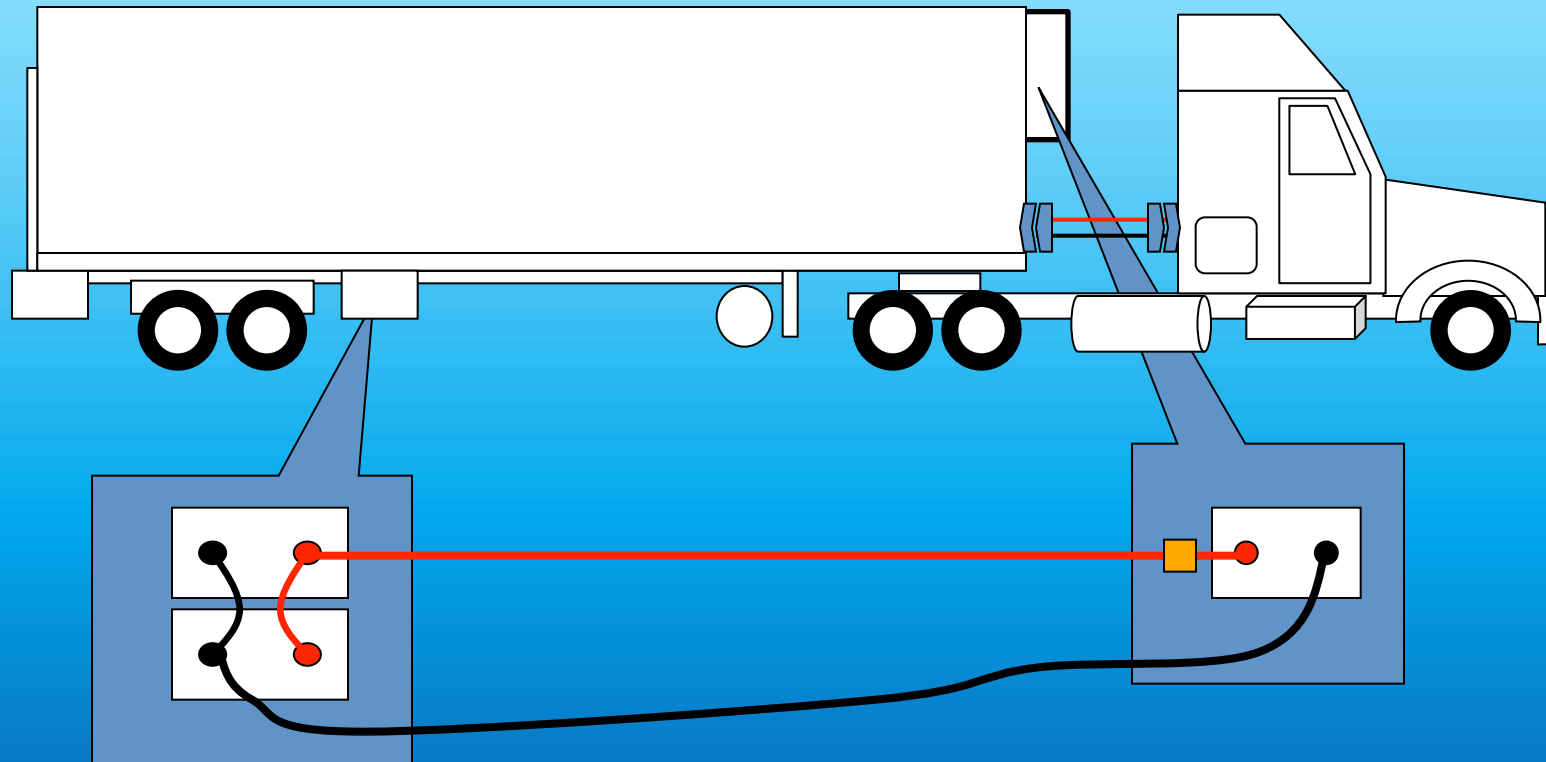

Reefer Charging Systems

- Trailer batteries connected in parallel with the reefer battery
- Still have voltage drop
- May overload reefer unit
- Reefer does not always run

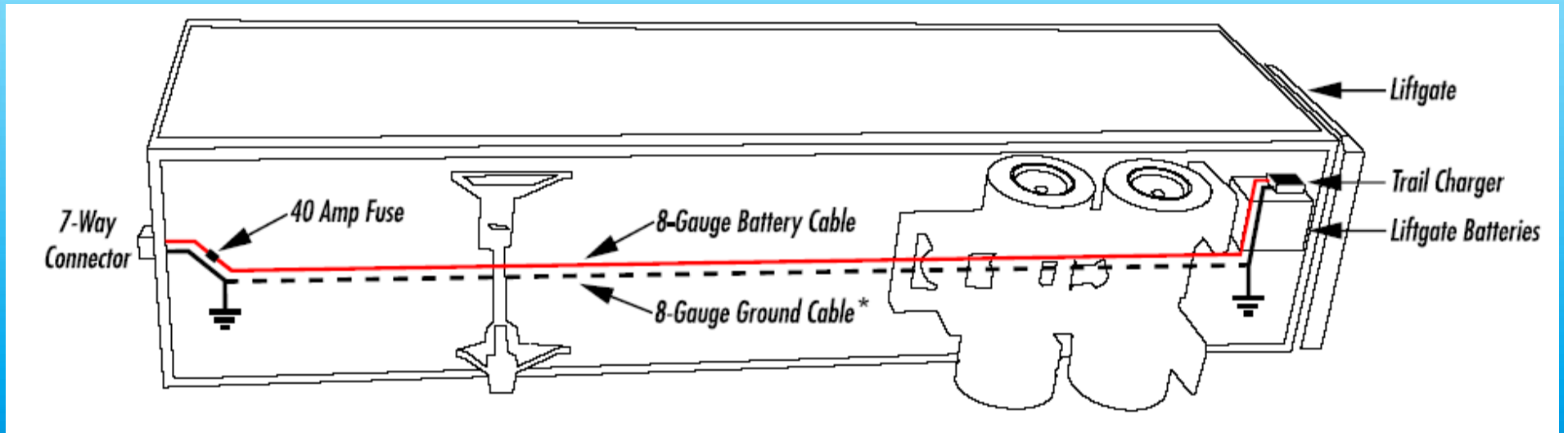

Connects to the Tractor Through the Auxiliary Pin
Key Switched Power

Traditional Charging Chart

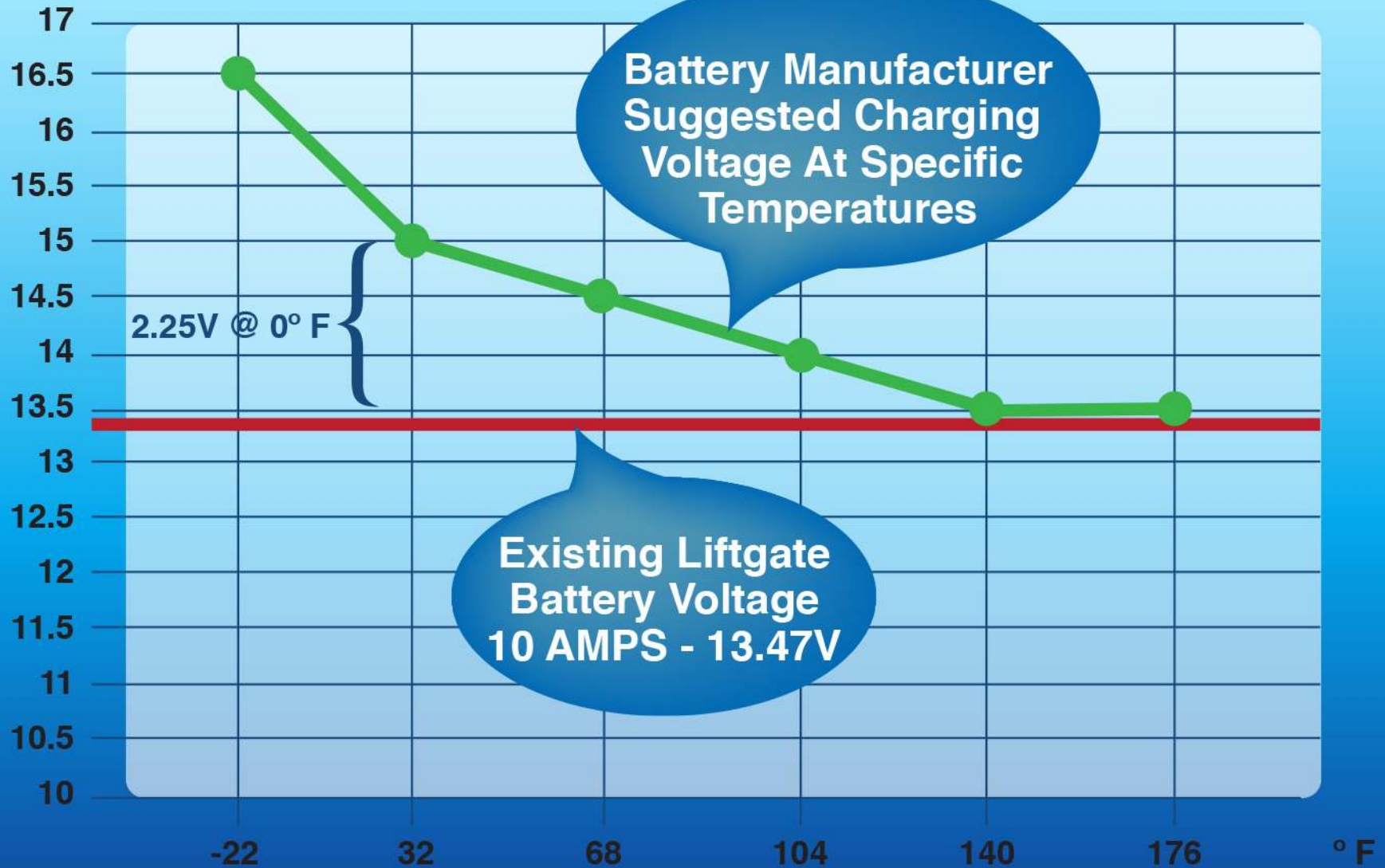

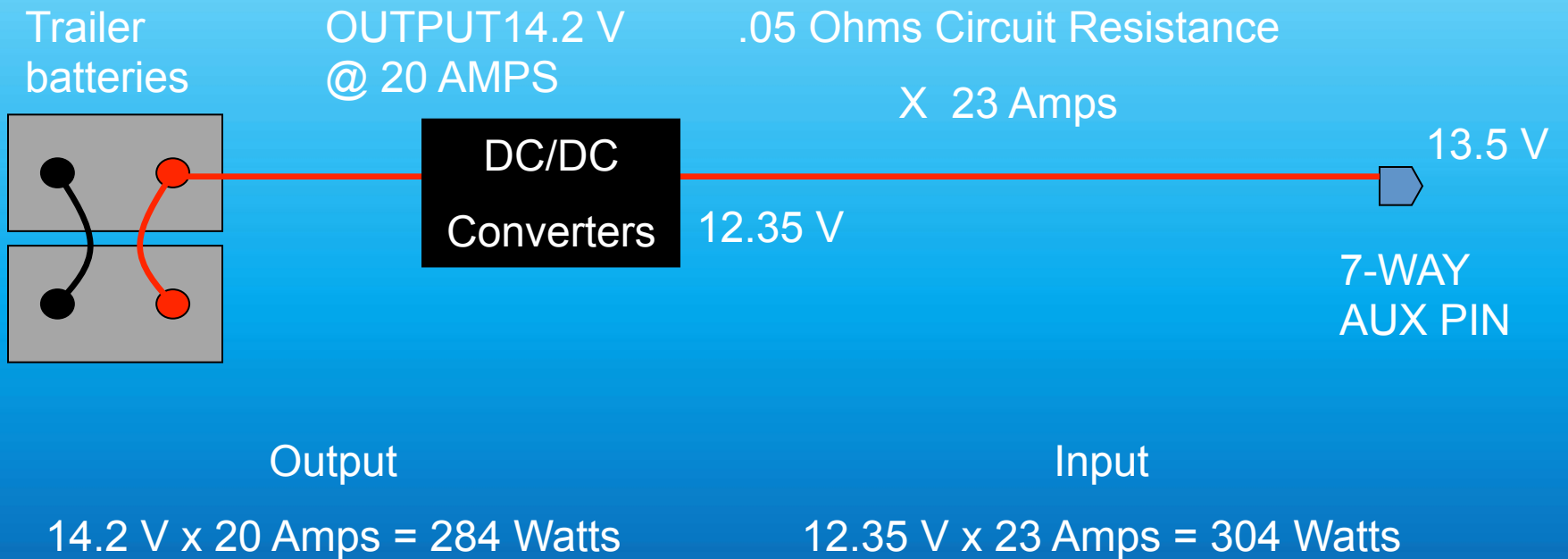

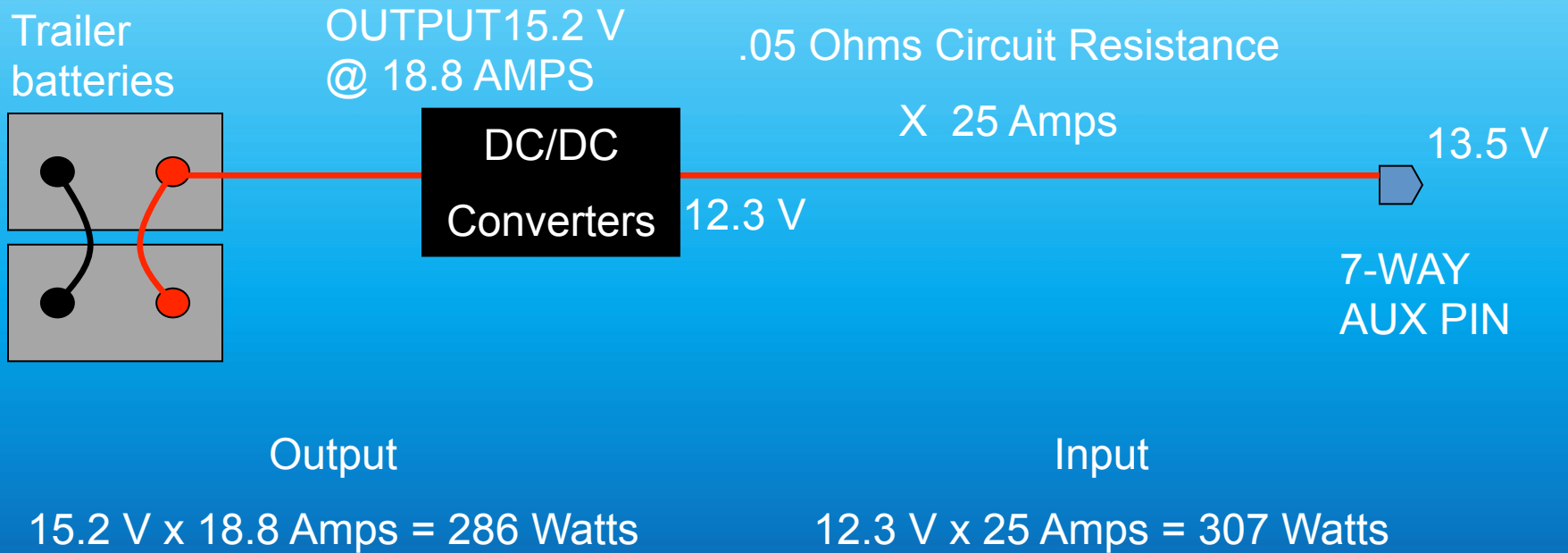

Trailcharger in Hot Weather

Output

$$14.2 \text{ V} \times 20 \text{ Amps} = 284 \text{ Watts}$$



Input

$$12.35 \text{ V} \times 23 \text{ Amps} = 304 \text{ Watts}$$



Trailcharger in Cold Weather

Output

$$15.2 \text{ V} \times 18.8 \text{ Amps} = 286 \text{ Watts}$$

Input

$$12.3 \text{ V} \times 25 \text{ Amps} = 307 \text{ Watts}$$

Don't Miss Our Next Webinar

Charging Liftgate Batteries - Part 2

"7-Way Aux Pin Circuit Liftgate Battery Charging Problems"

May 21, 2014 | 12:00 P.M. CDT

www.Purkeys.net/Events

Signup for Our Weekly E-Newsletter

- Case Studies About Charging Liftgate Batteries
- Tips and Tricks About Charging Liftgate Batteries
- More Valuable Information for Trucking Fleets

www.Purkeys.net/enews



Thank You!



PURKEYS

WATT Keeps You Trucking

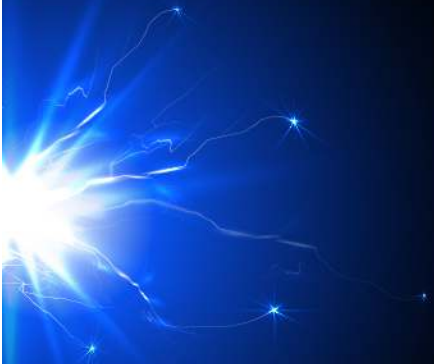

Bruce Purkey

Founder and Chief Creative Engineer

800-219-1269 | bpurkey@purkeys.net

